

#### **WARNING**

IMPORTANT: NEVER attempt any work without shutting off the electricity.

Read all instructions before installing.

System is intended for installation by a qualified electrician in accordance with the National Electrical Code and local regulations.

Go to the main fuse box, or circuit breaker. Place the main power switch in the "OFF" position and unscrew the fuse(s) or switch "OFF" the circuit breaker switch(es) that control the power to the fixture or room that you are working on.

Place the wall switch in the "OFF" position.

#### **CAUTION**

All parts must be used as indicated in these instructions. Do not substitute any parts, leave parts out, or use any parts that are worn out or broken.

Failure to follow this instruction could invalidate the ETL/CETL listing of this fixture.

CAUTION When handling the fixture, do not apply pressure to the LEDs. Hold the fixture by the base only.

#### **AVERTISSEMENT**

IMPORTANT : Coupez l'électricité avant TOUTE manipulation.

Lisez toutes les instructions avant d'installer.

Système est destiné à être installé par un électricien qualifié en conformité avec le code national de l'électricité et les règlements locaux.

Accédez au panneau central de disjoncteurs ou de fusibles de votre demeure et placez l'interrupteur principal en position d'arrêt (« OFF »).

Placez l'interrupteur mural en position d'arrêt (« OFF »).

#### **MISE EN GARDE**

Toutes les pièces doivent être utilisées tel qu'il est indiqué dans ces instructions. Ne remplacez pas les pièces, n'en laissez pas de côté et ne les utilisez pas si elles sont usées ou brisées. Le non-respect de ces instructions peut annuler l'homologation ETL/CETL du luminaire.

MISE EN GARDE Ors de la manipulation de l'appareil, ne pas appliquer de pression à la LED, tenir l'appareil par la seule base.

#### **ADVERTENCIA**

IMPORTANTE: NUNCA intente hacer trabajos sin desconectar el suministro eléctrico.

Lea y comprenda todas las instrucciones e ilustraciones por completo antes de proceder con el ensamblaje e instalación de esta lámpara.

Sistema está diseñado para ser instalado por un electricista calificado, de acuerdo con el código eléctrico nacional y las normas locales.

Diríjase a la caja de fusibles o a la caja del interruptor de circuito principal en su hogar. Coloque el interruptor de alimentación principal en la posición "OFF" (APAGADO).

Coloque el interruptor de la pared en la posición "OFF" (APAGADO).

#### **PRECAUCIÓN**

Todas las piezas deben usarse como lo indican estas instrucciones. No reemplace las piezas, no omita piezas durante la instalación ni utilice piezas gastadas o rotas. El incumplimiento de esta indicación podría invalidar la calificación ETL/CETL esta lámpara.

PRECAUCIÓN Al manipular el aparato, no aplique presión a los LED, mantenga el aparato en la base sólo.

1. Remove the canopy from packaging. Disassemble the mounting plate from the canopy by unscrewing the side screws, then put the mounting plate aside.



2. Take out one piece of SOCKET-PD-356-PN



3. Thread the braided wire from the canopy's cable gripper one by one. Adjust the wire to desired length as it passes through the cable gripper. Once you have the desired hanging length, leave at least 1.5' of wire inside the canopy and then cut the excess wire.

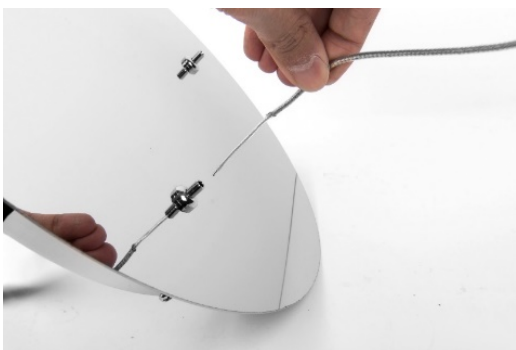

4. Trim outer insulation of 4" (four inches)



5. Make clean cut to remove 3.5" braided wire and leave remaining 1/2" braided wire. Make sure the braided wire is not frayed.



6. Position the collar and slide over braided wire so that a small section of remaining braided wire should reach the top or slightly beyond the top of the collar, protrudes from the top of the collar.



7. Trim 1/2" insulation from inner wire.



8. Take out yellow connecting terminal from socket accessories package, pass through braided wire end and push in metal collar in yellow connecting terminal



09. Take out the 22# black wire (One end is soft and one end is hard) from the socket accessories package, and insert **hard** wicked end into yellow connecting terminal

10. Thread the braided wire into the yellow connecting terminal. The yellow connecting terminal should be completely covering the metal collar.

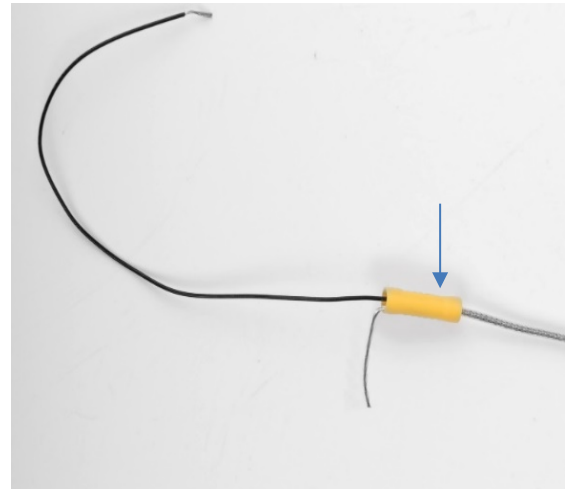
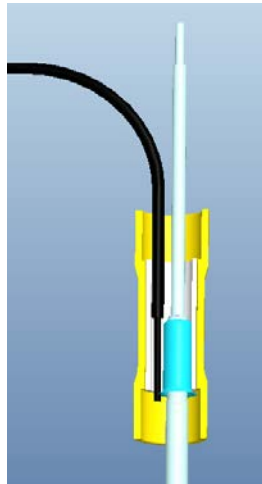

11. To secure connection, Clamp the yellow connecting terminal at the rivet end by using wire clamp. This will hold and connect the black wire to the metal collar as shown.

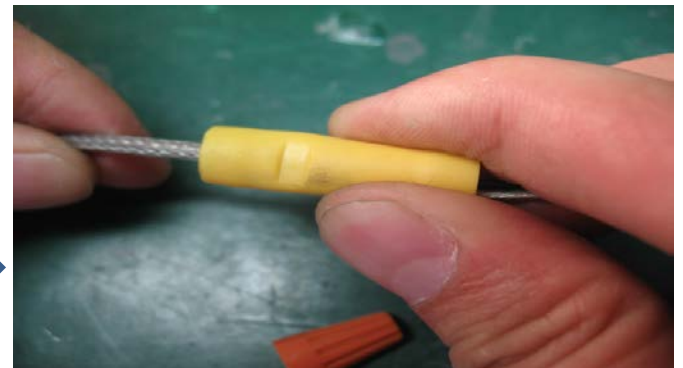
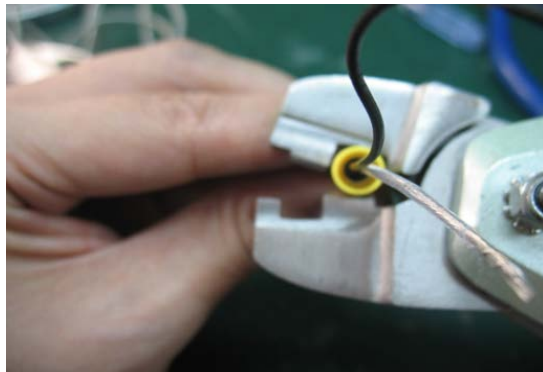

12. Repeat **Step 3-11** for the rest of the socket.

Tandem connect the wires: Use wire nut to connect the 22# black wire with the open braided wire from other socket. (see below)

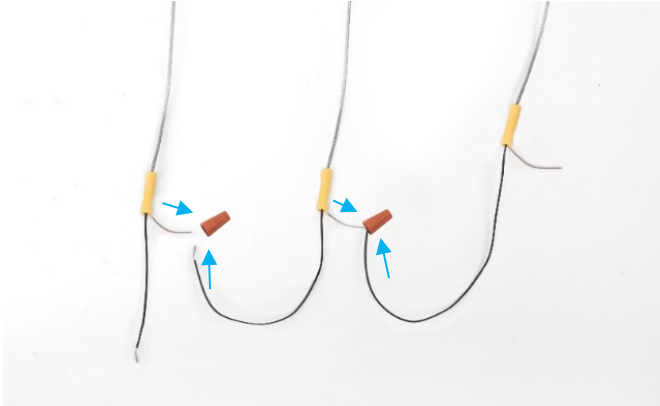

**Important:** Magic (5 Light) pendant will have 2 pre-installed drivers on the canopy and the maximum wattage of each driver could connect up to 4 fixtures. Therefore you will need to tandem connect the wires by 1 group of 3 socket wire string + 1 group of 2 socket wire string. (see Fig 1.1)

13. Connect the driver's output wires to the socket wire string.

*Please noted the driver will have one sided black/red and black/white wire, make sure to use black/red wire side for the socket wire string.*

Connect the 22# black wire from the socket wire string to black wire from driver, and the inner wire from the string to red wire from driver with wire nuts. (see below)

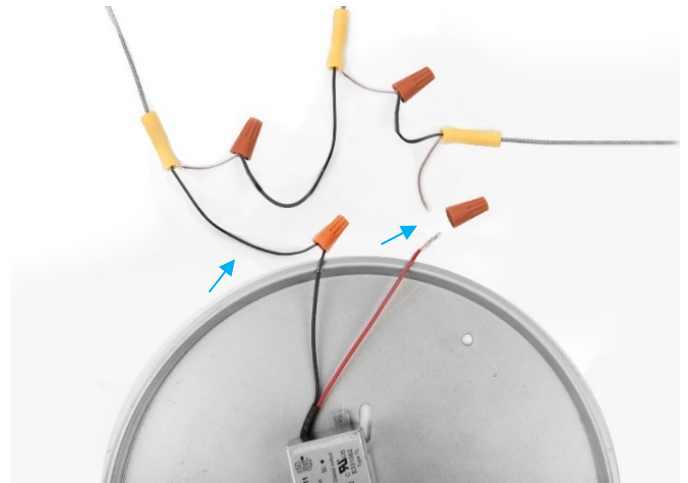
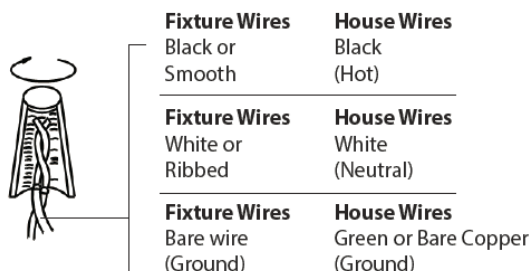

**Fig 1.1**

*Please note maximum of 3 SOCKET PD-356-PN connection per driver.*

14. Drill a hole in the ceiling aligned with the key hole located in the mounting back plate, insert the plastic anchor (E1).
15. Adjust the fixture wire length by pushing the cable gripper on the canopy and pulling the wire as desired.
16. Connect the driver input wires with junction box wires as shown in **Fig. 2**, making sure that all wire connectors (A1) are secured. If your outlet box has a green or bare copper ground wire, connect the fixture's ground wire to it. Otherwise, connect the fixture's ground wire directly to the mounting plate using the green screw provided. After wires are connected, tuck them carefully inside the junction box.  
**\*Require Driver to be recessed within the junction box.**

**FIG. 2: WIRING**



17. Secure mounting plate to the junction box using junction box screws (B1). The side of the mounting plate marked "GND" must face out.
18. Place the fixture over the mounting plate and secure it with mounting screws (C1).
19. Thread the noodle glass onto the lamp body.

**FIG. 1**

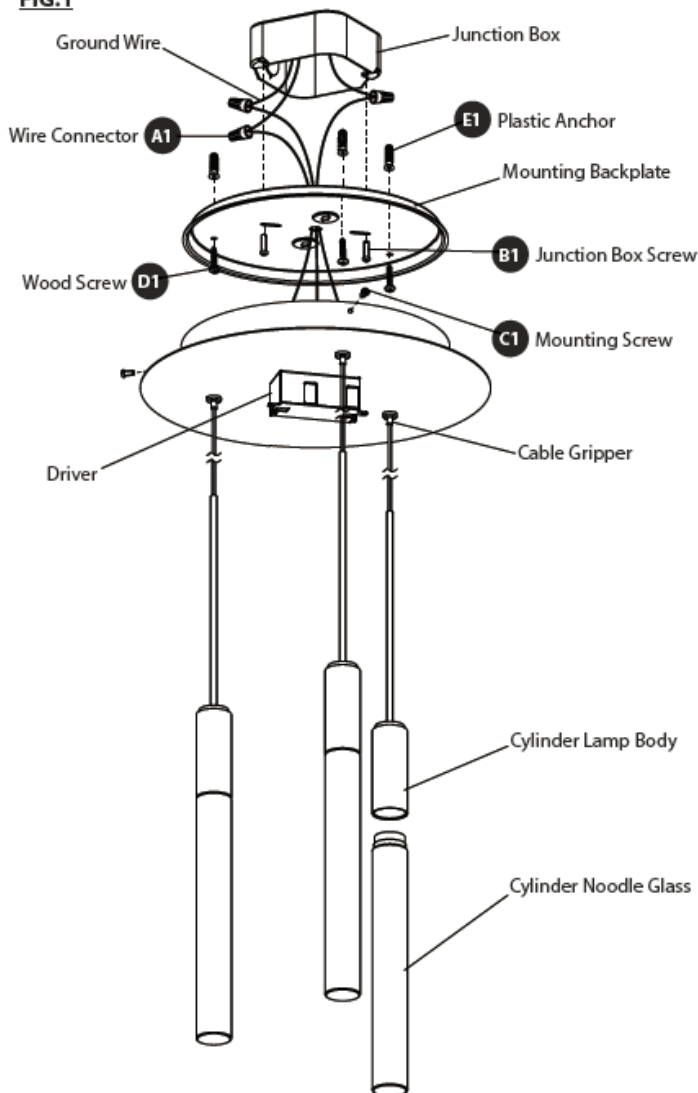

**Back Plate Dimensions**

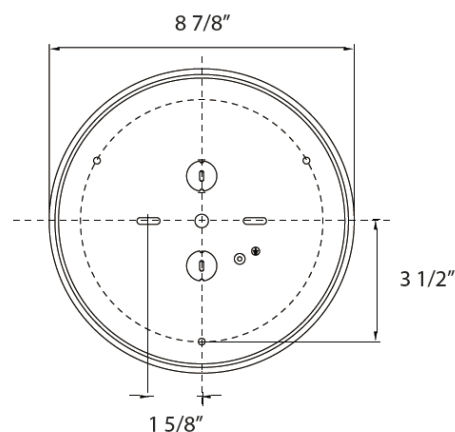

#### **WARNING**

IMPORTANT: NEVER attempt any work without shutting off the electricity.

Read all instructions before installing.

System is intended for installation by a qualified electrician in accordance with the National Electrical Code and local regulations.

Go to the main fuse box, or circuit breaker. Place the main power switch in the "OFF" position and unscrew the fuse(s) or switch "OFF" the circuit breaker switch(es) that control the power to the fixture or room that you are working on.

Place the wall switch in the "OFF" position.

#### **CAUTION**

All parts must be used as indicated in these instructions. Do not substitute any parts, leave parts out, or use any parts that are worn out or broken.

Failure to follow this instruction could invalidate the ETL/CETL listing of this fixture.

CAUTION When handling the fixture, do not apply pressure to the LEDs. Hold the fixture by the base only.

#### **AVERTISSEMENT**

IMPORTANT : Coupez l'électricité avant TOUTE manipulation.

Lisez toutes les instructions avant d'installer.

Système est destiné à être installé par un électricien qualifié en conformité avec le code national de l'électricité et les règlements locaux.

Accédez au panneau central de disjoncteurs ou de fusibles de votre demeure et placez l'interrupteur principal en position d'arrêt (« OFF »).

Placez l'interrupteur mural en position d'arrêt (« OFF »).

#### **MISE EN GARDE**

Toutes les pièces doivent être utilisées tel qu'il est indiqué dans ces instructions. Ne remplacez pas les pièces, n'en laissez pas de côté et ne les utilisez pas si elles sont usées ou brisées. Le non-respect de ces instructions peut annuler l'homologation ETL/CETL du luminaire.

MISE EN GARDE Ors de la manipulation de l'appareil, ne pas appliquer de pression à la LED, tenir l'appareil par la seule base.

#### **ADVERTENCIA**

IMPORTANTE: NUNCA intente hacer trabajos sin desconectar el suministro eléctrico.

Lea y comprenda todas las instrucciones e ilustraciones por completo antes de proceder con el ensamblaje e instalación de esta lámpara.

Sistema está diseñado para ser instalado por un electricista calificado, de acuerdo con el código eléctrico nacional y las normas locales.

Diríjase a la caja de fusibles o a la caja del interruptor de circuito principal en su hogar. Coloque el interruptor de alimentación principal en la posición "OFF" (APAGADO).

Coloque el interruptor de la pared en la posición "OFF" (APAGADO).

#### **PRECAUCIÓN**

Todas las piezas deben usarse como lo indican estas instrucciones. No reemplace las piezas, no omita piezas durante la instalación ni utilice piezas gastadas o rotas. El incumplimiento de esta indicación podría invalidar la calificación ETL/CETL esta lámpara.

PRECAUCIÓN Al manipular el aparato, no aplique presión a los LED, mantenga el aparato en la base sólo.



1. Remove the canopy from packaging. Disassemble the mounting plate from the canopy by unscrewing the side screws, then put the mounting plate aside.



2. Take out one piece of SOCKET-PD-356-PN



3. Thread the braided wire from the canopy's cable gripper one by one. Adjust the wire to desired length as it passes through the cable gripper. Once you have the desired hanging length, leave at least 1.5' of wire inside the canopy and then cut the excess wire.

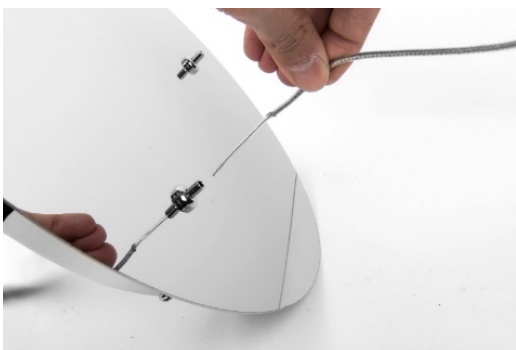

4. Trim outer insulation of 4" (four inches)



5. Make clean cut to remove 3.5" braided wire and leave remaining 1/2" braided wire. Make sure the braided wire is not frayed.



6. Position the collar and slide over braided wire so that a small section of remaining braided wire should reach the top or slightly beyond the top of the collar, protrudes from the top of the collar.



7. Trim 1/2" insulation from inner wire.



8. Take out yellow connecting terminal from socket accessories package, pass through braided wire end and push in metal collar in yellow connecting terminal



09. Take out the 22# black wire (One end is soft and one end is hard) from the socket accessories package, and insert **hard** wicked end into yellow connecting terminal

10. Thread the braided wire into the yellow connecting terminal. The yellow connecting terminal should be completely covering the metal collar.

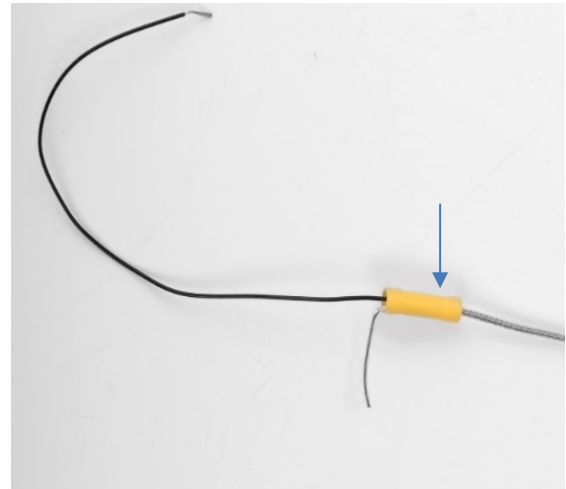
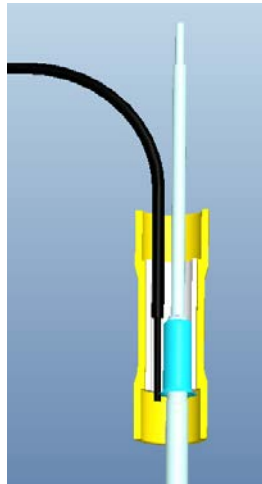

11. To secure connection, Clamp the yellow connecting terminal at the rivet end by using wire clamp. This will hold and connect the black wire to the metal collar as shown.

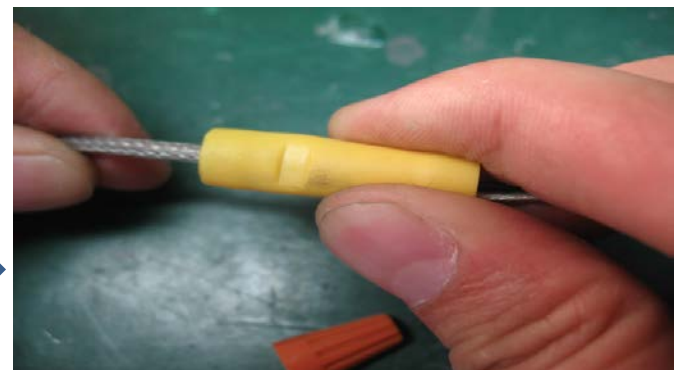
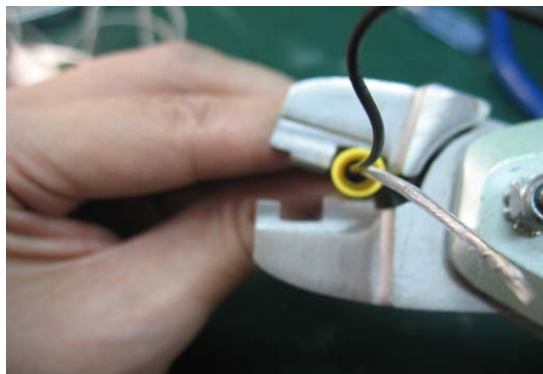



12. Repeat **Step 3-11** for the rest of the socket.

Tandem connect the wires: Use wire nut to connect the 22# black wire with the open braided wire from other socket. (see below)

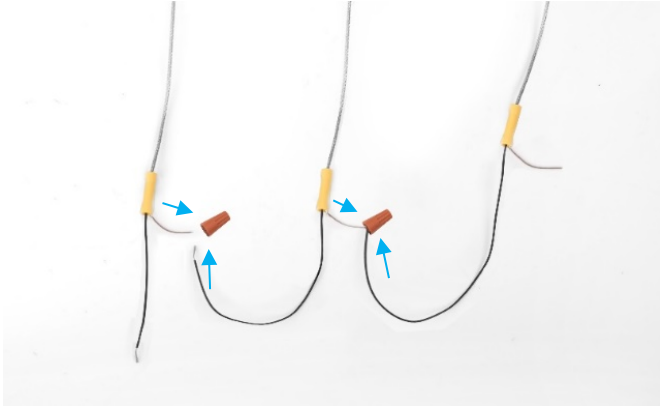

**Important:** Magic (5 Light) pendant will have 2 pre-installed drivers on the canopy and the maximum wattage of each driver could connect up to 4 fixtures. Therefore you will need to tandem connect the wires by 1 group of 3 socket wire string + 1 group of 2 socket wire string. (see Fig 1.1)

13. Connect the driver's output wires to the socket wire string.

*Please noted the driver will have one sided black/red and black/white wire, make sure to use black/red wire side for the socket wire string.*

Connect the 22# black wire from the socket wire string to black wire from driver, and the inner wire from the string to red wire from driver with wire nuts. (see below)

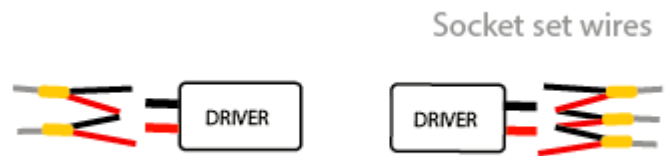
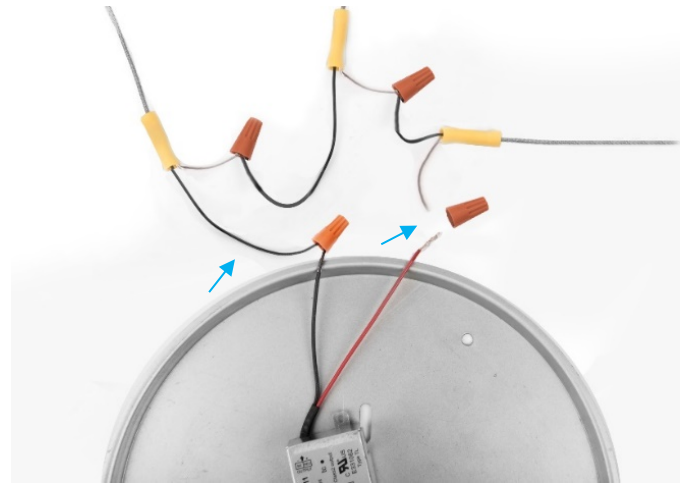
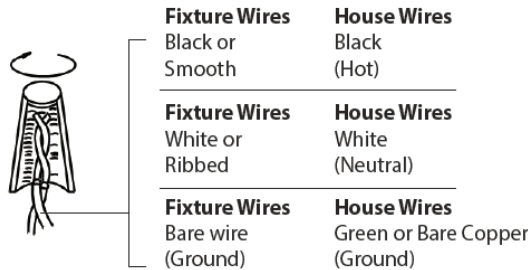

**Fig 1.1**

*Please note maximum of 3 SOCKET PD-356-PN connection per driver.*

14. Drill a hole in the ceiling aligned with the key hole located in the mounting back plate, insert the plastic anchor (E1).
15. Adjust the fixture wire length by pushing the cable gripper on the canopy and pulling the wire as desired.
16. Connect the driver input wires with junction box wires as shown in Fig. 2, making sure that all wire connectors (A1) are secured. If your outlet box has a green or bare copper ground wire, connect the fixture's ground wire to it. Otherwise, connect the fixture's ground wire directly to the mounting plate using the green screw provided. After wires are connected, tuck them carefully inside the junction box.  
**\*Require Driver to be recessed within the junction box.**

**FIG. 2: WIRING**



17. Secure mounting plate to the junction box using junction box screws (B1). The side of the mounting plate marked "GND" must face out.
18. Place the fixture over the mounting plate and secure it with mounting screws (C1).
19. Thread the noodle glass onto the lamp body.

**FIG. 1**

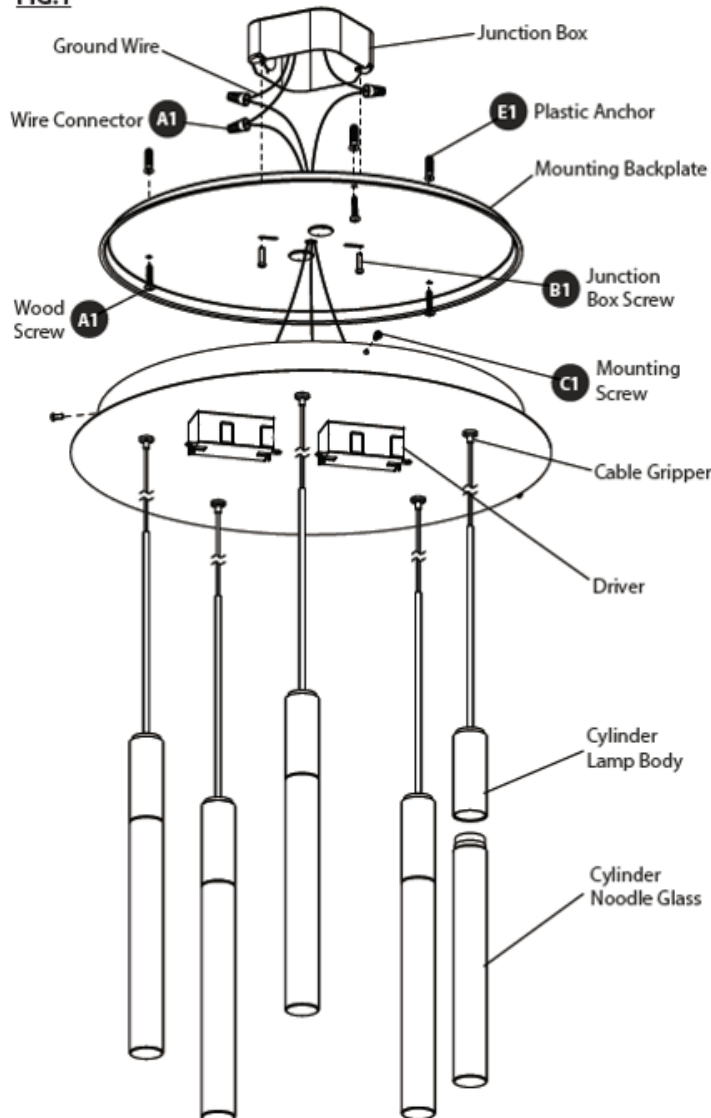

**Back Plate Dimensions**

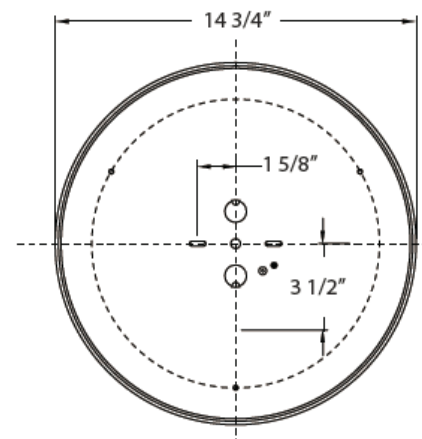

#### **WARNING**

IMPORTANT: NEVER attempt any work without shutting off the electricity.

Read all instructions before installing.

System is intended for installation by a qualified electrician in accordance with the National Electrical Code and local regulations.

Go to the main fuse box, or circuit breaker. Place the main power switch in the "OFF" position and unscrew the fuse(s) or switch "OFF" the circuit breaker switch(es) that control the power to the fixture or room that you are working on.

Place the wall switch in the "OFF" position.

#### **CAUTION**

All parts must be used as indicated in these instructions. Do not substitute any parts, leave parts out, or use any parts that are worn out or broken.

Failure to follow this instruction could invalidate the ETL/CETL listing of this fixture.

CAUTION When handling the fixture, do not apply pressure to the LEDs. Hold the fixture by the base only.

#### **AVERTISSEMENT**

IMPORTANT : Coupez l'électricité avant TOUTE manipulation.

Lisez toutes les instructions avant d'installer.

Système est destiné à être installé par un électricien qualifié en conformité avec le code national de l'électricité et les règlements locaux.

Accédez au panneau central de disjoncteurs ou de fusibles de votre demeure et placez l'interrupteur principal en position d'arrêt (« OFF »).

Placez l'interrupteur mural en position d'arrêt (« OFF »).

#### **MISE EN GARDE**

Toutes les pièces doivent être utilisées tel qu'il est indiqué dans ces instructions. Ne remplacez pas les pièces, n'en laissez pas de côté et ne les utilisez pas si elles sont usées ou brisées. Le non-respect de ces instructions peut annuler l'homologation ETL/CETL du luminaire.

MISE EN GARDE Ors de la manipulation de l'appareil, ne pas appliquer de pression à la LED, tenir l'appareil par la seule base.

#### **ADVERTENCIA**

IMPORTANTE: NUNCA intente hacer trabajos sin desconectar el suministro eléctrico.

Lea y comprenda todas las instrucciones e ilustraciones por completo antes de proceder con el ensamblaje e instalación de esta lámpara.

Sistema está diseñado para ser instalado por un electricista calificado, de acuerdo con el código eléctrico nacional y las normas locales.

Diríjase a la caja de fusibles o a la caja del interruptor de circuito principal en su hogar. Coloque el interruptor de alimentación principal en la posición "OFF" (APAGADO).

Coloque el interruptor de la pared en la posición "OFF" (APAGADO).

#### **PRECAUCIÓN**

Todas las piezas deben usarse como lo indican estas instrucciones. No reemplace las piezas, no omita piezas durante la instalación ni utilice piezas gastadas o rotas. El incumplimiento de esta indicación podría invalidar la calificación ETL/CETL esta lámpara.

PRECAUCIÓN Al manipular el aparato, no aplique presión a los LED, mantenga el aparato en la base sólo.

1. Remove the canopy from packaging. Disassemble the mounting plate from the canopy by unscrewing the side screws, then put the mounting plate aside.



2. Take out one piece of SOCKET-PD-356-PN



3. Thread the braided wire from the canopy's cable gripper one by one. Adjust the wire to desired length as it passes through the cable gripper. Once you have the desired hanging length, leave at least 1.5' of wire inside the canopy and then cut the excess wire.

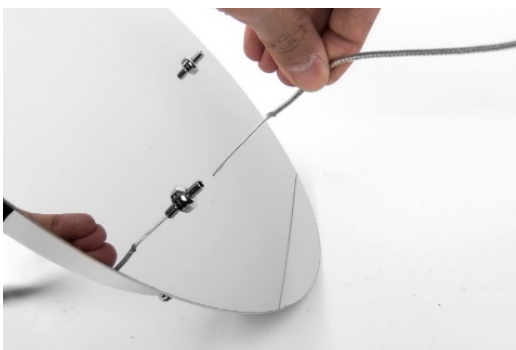

4. Trim outer insulation of 4" (four inches)



5. Make clean cut to remove 3.5" braided wire and leave remaining 1/2" braided wire. Make sure the braided wire is not frayed.



6. Position the collar and slide over braided wire so that a small section of remaining braided wire should reach the top or slightly beyond the top of the collar, protrudes from the top of the collar.



7. Trim 1/2" insulation from inner wire.



8. Take out yellow connecting terminal from socket accessories package, pass through braided wire end and push in metal collar in yellow connecting terminal



09. Take out the 22# black wire (One end is soft and one end is hard) from the socket accessories package, and insert **hard** wicked end into yellow connecting terminal

10. Thread the braided wire into the yellow connecting terminal. The yellow connecting terminal should be completely covering the metal collar.

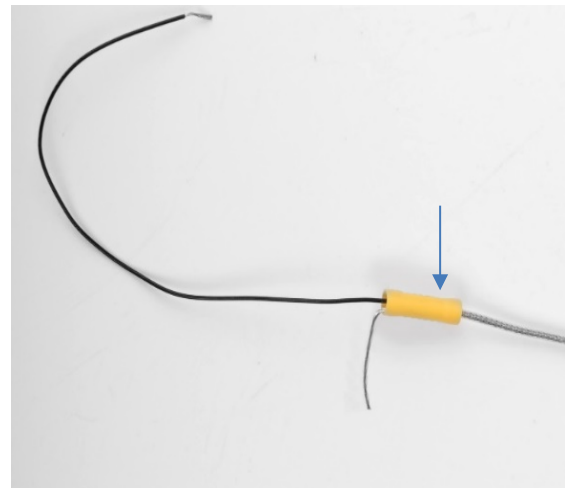
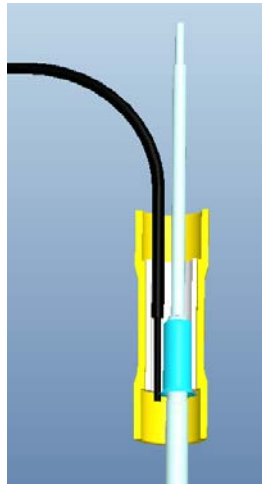

11. To secure connection, Clamp the yellow connecting terminal at the rivet end by using wire clamp. This will hold and connect the black wire to the metal collar as shown.

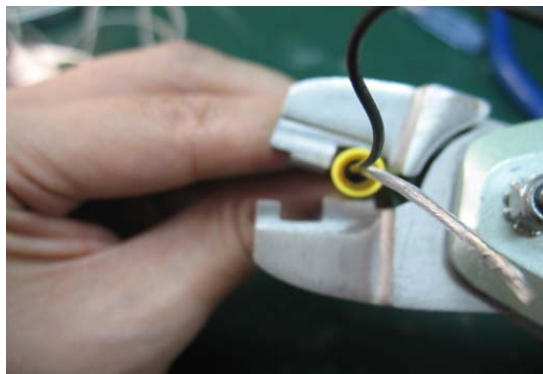

12. Repeat **Step 3-11** for the rest of the socket.

Tandem connect the wires: Use wire nut to connect the 22# black wire with the open braided wire from other socket. (see below)

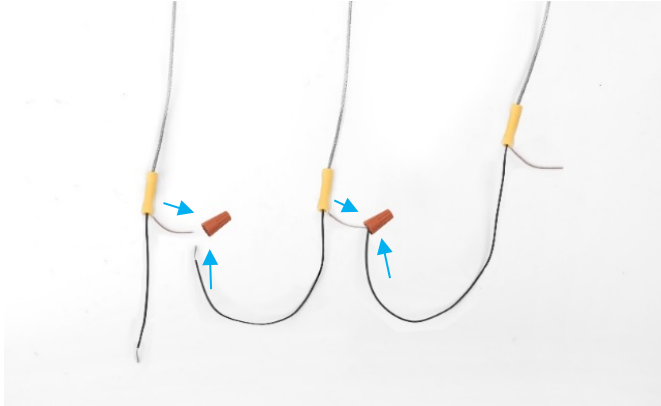

**Important:** Magic (5 Light) pendant will have 2 pre-installed drivers on the canopy and the maximum wattage of each driver could connect up to 4 fixtures. Therefore you will need to tandem connect the wires by 1 group of 3 socket wire string + 1 group of 2 socket wire string. (see Fig 1.1)

13. Connect the driver's output wires to the socket wire string.

*Please noted the driver will have one sided black/red and black/white wire, make sure to use black/red wire side for the socket wire string.*

Connect the 22# black wire from the socket wire string to black wire from driver, and the inner wire from the string to red wire from driver with wire nuts. (see below)

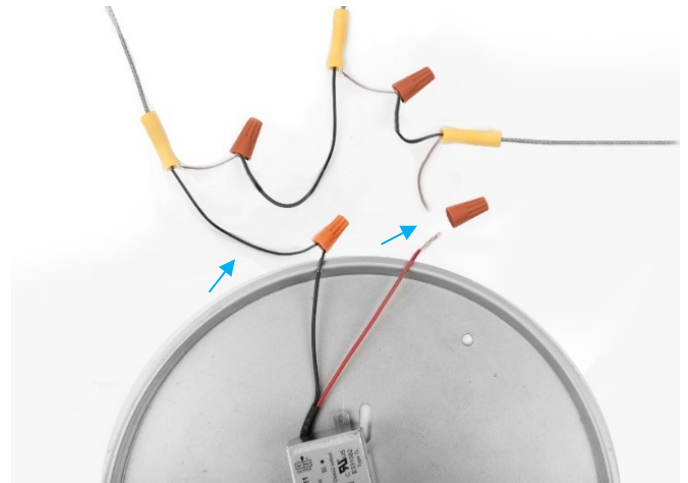

**Fig 1.1**

*Please note maximum of 3 SOCKET PD-356-PN connection per driver.*



14. Drill a hole in the ceiling aligned with the key hole located in the mounting back plate, insert the plastic anchor (E1).
15. Adjust the fixture wire length by pushing the cable gripper on the canopy and pulling the wire as desired.
16. Connect the driver input wires with junction box wires as shown in Fig. 2, making sure that all wire connectors (A1) are secured. If your outlet box has a green or bare copper ground wire, connect the fixture's ground wire to it. Otherwise, connect the fixture's ground wire directly to the mounting plate using the green screw provided. After wires are connected, tuck them carefully inside the junction box.  
**\*Require Driver to be recessed within the junction box.**

**FIG. 2: WIRING**

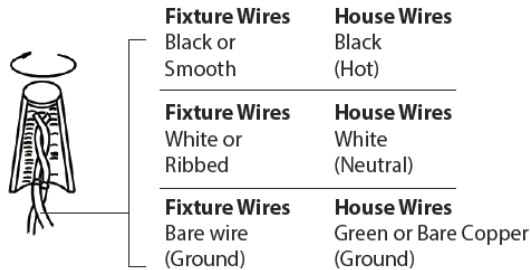

17. Secure mounting plate to the junction box using junction box screws (B1). The side of the mounting plate marked "GND" must face out.
18. Place the fixture over the mounting plate and secure it with mounting screws (C1).
19. Thread the noodle glass onto the lamp body.

